



(REVIEW ARTICLE)



Performance analysis and optimization of next-generation thermal energy storage

Jaymin Pareshkumar Shah *

ITM SLS Baroda University, India.

World Journal of Advanced Engineering Technology and Sciences, 2024, 12(01), 514-527

Publication history: Received on 16 April 2024 revised on 22 May 2024; accepted on 24 May 2024

Article DOI: <https://doi.org/10.30574/wjaets.2024.12.1.0209>

Abstract

Thermal energy storage can play a very important role in improving energy efficiency and integrating renewable energy into large-scale applications. This paper reviews the different types of TES technologies, their applications, challenges, and future prospects. The work describes the key technical constraints, economic and environment concerns, and political and regulatory frameworks which determine the uptake of TES systems. Issues related to improved materials, optimized systems, and integration with new energy technologies are considered in order to determine the future potentials of TES in sustainable energy solutions. The study finds that despite the high potentials TES technologies offer in energy supply stabilization and improving grid reliability, the technologies have scalability challenges; challenges in cost of materials; and efficiency of systems. Solutions for the challenges required continuous research in advanced thermal storage materials, better system designs, and supportive policy interventions. Some areas recommended for future research include exploration of new storage media, development of high efficiency thermal cycles even for high temperature operations, and hybrid energy systems for improving the performance of TES. This paper also demonstrates the great importance of TES in the sustainable and resilient energy future.

Keywords: Thermal Energy Storage; Energy Efficiency; Renewable Energy; Sustainable Energy Systems; Phase Change Materials; Sensible Heat Storage; Latent Heat Storage; Policy Frameworks; Energy Grid Stability; Advanced Energy Materials

1. Introduction

1.1. Overview of Thermal Energy Storage (TES)

Thermal Energy Storage (TES) architecture is of utmost importance to modern energy systems, as it provides storage and release options for thermal energy for several applications, including power generation, industrial processes, heating, and cooling systems. As the world energy requirements grow more and more, efficient and sustainable storage solutions are becoming increasingly important. Therefore, TES provides a mode of storage so that the excess thermal energy can be stored when the supply exceeds demand and can be discharged to fulfill energy needs, thus preventing wastage and improving the efficiency of the system along with grid flexibility. More so particularly, when energy needs to be integrated from a renewables' point of view, TES counters intermittency issues associated with solar and wind by storing excess energy during a period of high production and releasing it when there are low production times (Caraballo et al., 2021). Reduce dependence on fossil fuel-based backup systems and supports load leveling is the TES that provides energy security and stability in large scale (Baigorri et al., 2023).

* Corresponding author: Jaymin Pareshkumar Shah

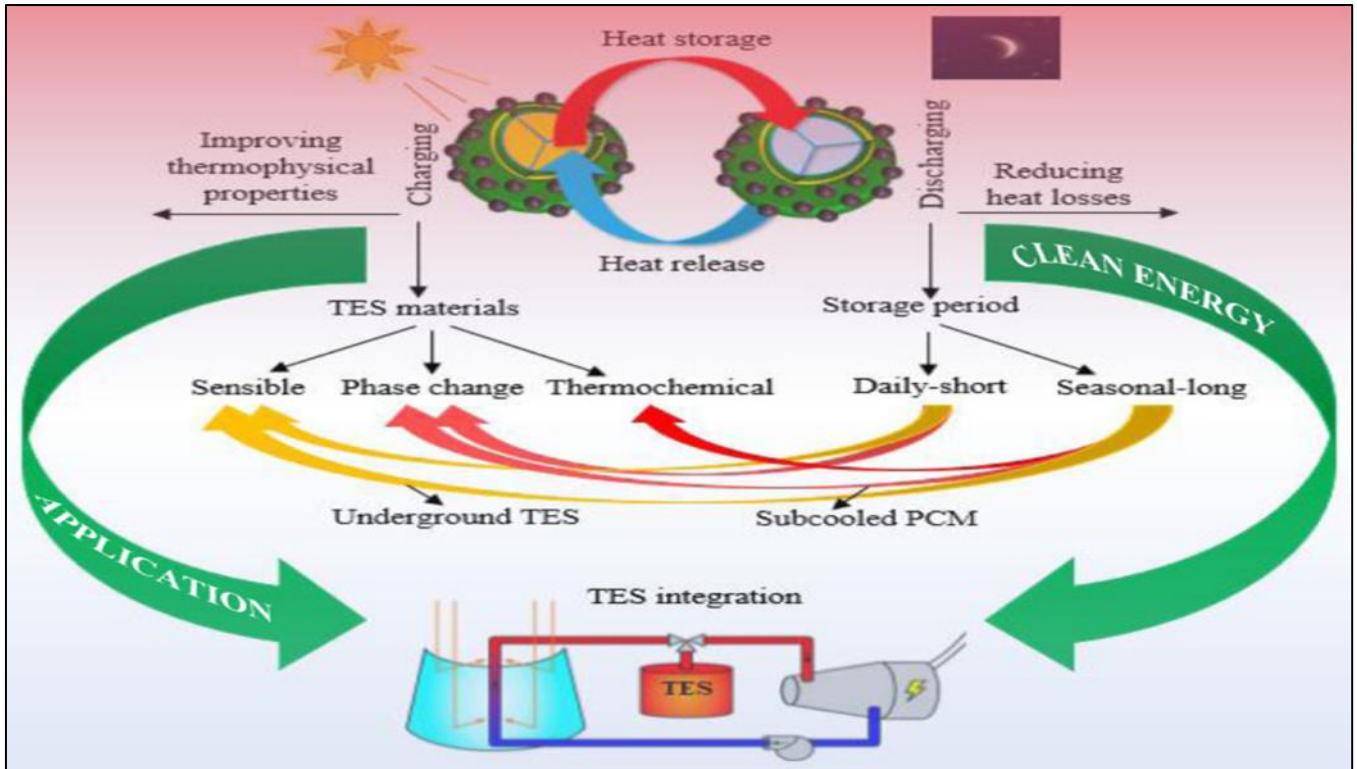

Figure 1 Energy Storage on demand: Thermal Energy Storage Development, Materials, Design and Integration Challenges

TES technologies can broadly be founded on three main types of energy storage mechanisms. Sensible heat storage is the most conventional, relying on varying temperature changes in storage materials such as water, rocky materials, or molten salts to store and release thermal energy. This method of storing thermal energy has become popular mainly due to its simplicity and cost-effectiveness for large-scale application, especially concentrating solar power (CSP) plants. Latent heat storage, on another hand, makes use of phase change materials (PCMs) that absorb and release energies in phase changes such as in solid-to-liquid or liquid-to-gas transitions. Furthermore, it is this way that latent heat storage outperforms sensible heat storage by being highly recommended for applications in thermal management where a constant temperature must be maintained. Thermochemical energy storage describes the third method among the three. It resorts to the uses of reversible chemical reactions to store and retrieve energy. This process results in much higher energy density than either sensible heat storage or latent heat storage, becoming a good candidate for long-term energy storage and transportable thermal applications (Kant et al., 2017).

It has been clear from the ongoing and on-going pioneering of TES technologies that such developments emerged and motivated mainly due to the performance enhancement, efficiency improvement, and cost effectiveness of the technology. Other materials that can still pass consideration for the new and advanced materials are nanocomposites, high-temperature ceramics, or some new formulations of PCM to improve heat absorption and retention and transfer rate. All kinds of novel system designs involve different hybrid TES configurations with multiple storage mechanisms for optimal energy storage capacity and operation flexibility. With continuing efforts in decarbonization and energy sustainability, such will be on the increase in importance in optimizing energy systems, reducing greenhouse gas emissions, and facilitating transition to sustainable energy infrastructure.

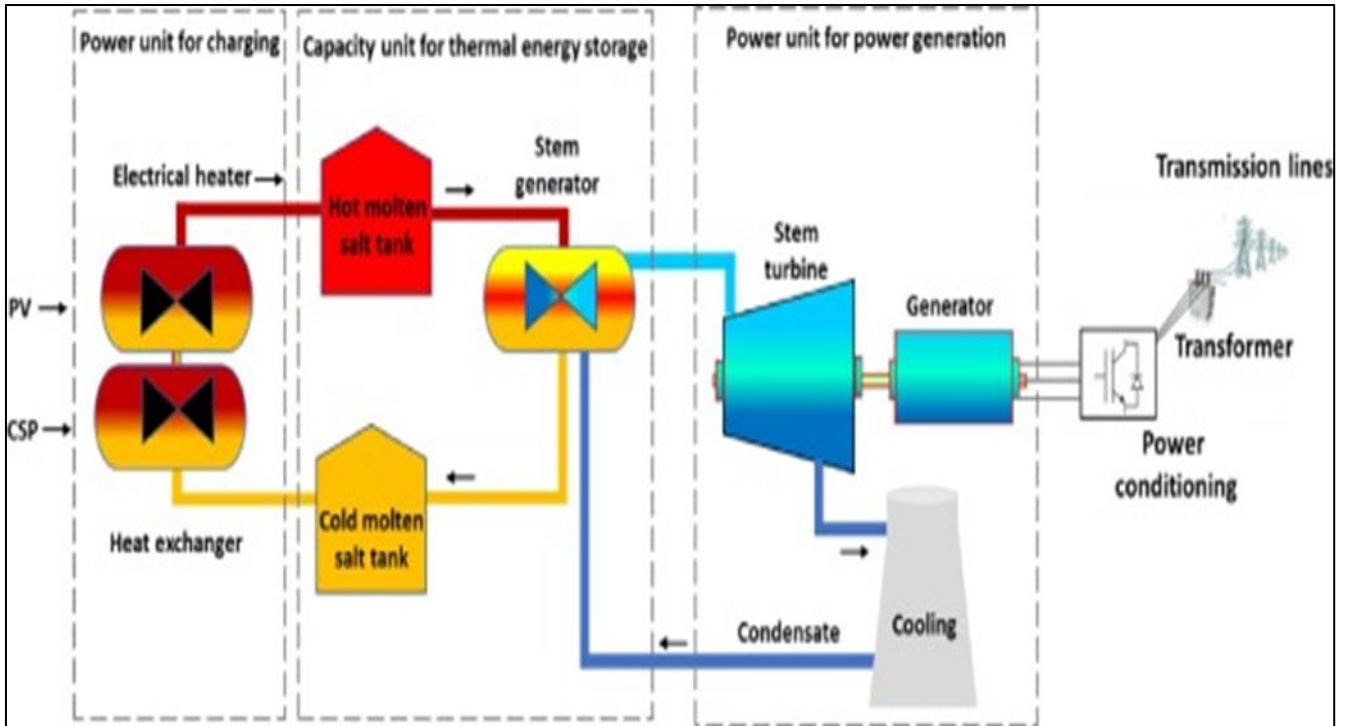

Figure 2 An Overview of Thermal Energy Storage

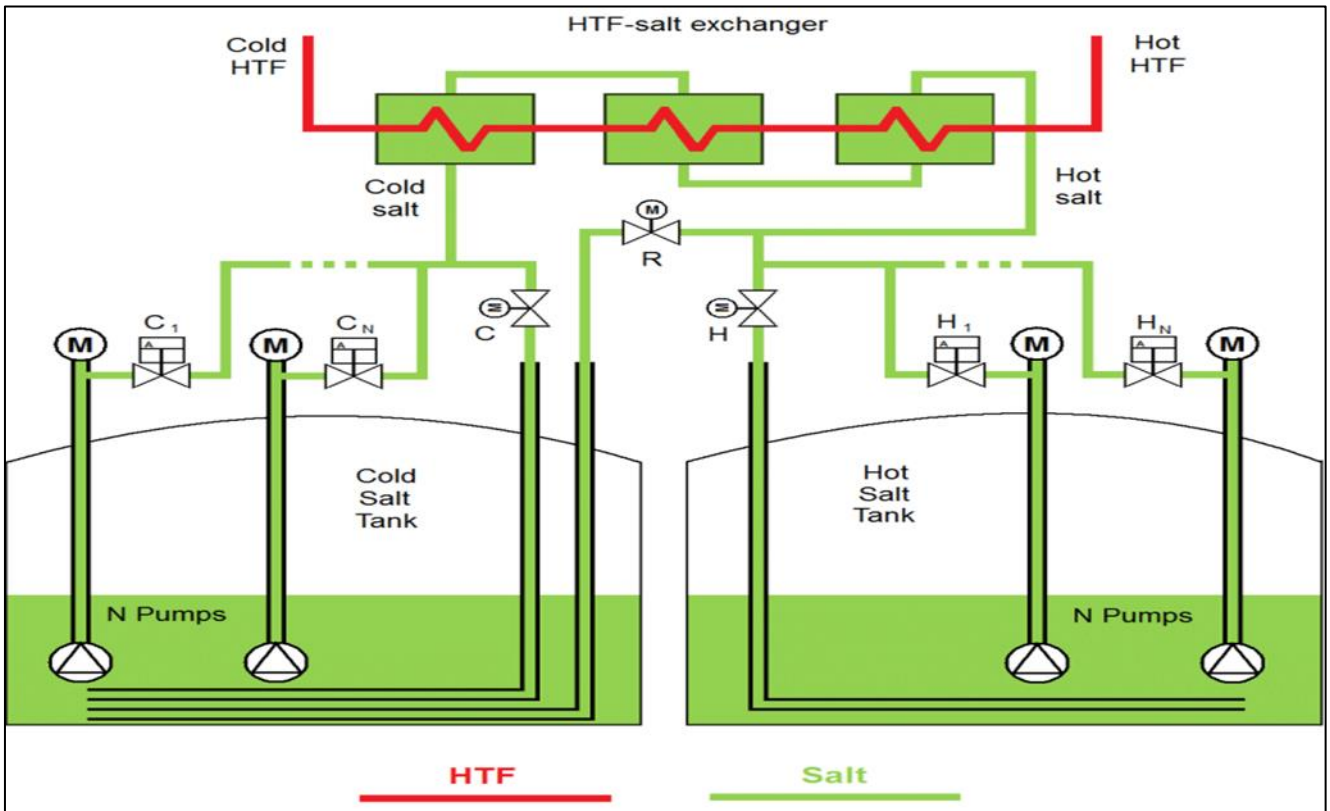

Figure 3 Schematic of a Thermal Energy Storage System

1.2. Importance of TES in Renewable Energy Integration and Sustainability

Connecting this technology to energy sources, renewable energy sources provide a way forward for addressing the intermittency problem associated with the conversion of solar and wind energy into electricity. Such energy sources

remain variable owing to solar generation dependence on sunlight; when there is no sunlight, there's no generation. Wind energy, too, varies depending on changing speeds of wind. In an inappropriate storage scheme, excess energy generated during peak times will not be absorbed and will eventually go to waste, thus reducing productivity and possibly destabilizing the grid. It stores all the additional energy produced at times when production exceeds demand, and it will then release that energy when the opposite is true, providing a steady, reliable output. It serves to stabilize the grid, secure energy supply, and reduce reliance on such backup backup systems, often expensive, and contributing much to greenhouse gas emissions (Odukamaiya et al., 2021). The TES systems make it possible for renewables to achieve powerful predictability in generation of power. Hence it increases the efficiency of what can be added to the grid from clean sources and contributes to making energy systems resilient and sustainable (Hamdan et al., 2024).

In concentrated solar power (CSP) production, the TES systems contribute to the increasing operational hours of the plant since they allow the capturing of heat energy during the day, making it available for use in generation when there is no sunlight. CSP plants, therefore, run round-the-clock because they have moved away from the dismal production modes of photovoltaic solar arrays that produce power only when there is light. Saldivia et al. (2021) investigated the role of TES in CSP plants for different beam-down receiver systems and underlined a possibility to enlarge thermal efficiency, minimizing energy losses, and general improvement of efficiency. The addition of TESs in CSP plants has really changed the whole game for solar applications and made large-scale solar economically feasible.

Apart from power generation, TES has been laid down to cover its use in most industrial activities, whereby it features in waste heat recovery. Many industrial processes release waste heat in considerable amounts, which, if not captured, translates into the loss of significant energy. TES is integrated into an industrial facility such that all excess heat is captured and stored for use when demand calls with an improvement in energy efficiency and a lowered operational cost. Mellouli et al. (2018) reviewed applications of TES towards industrial waste heat recovery and proved it could drastically reduce energy consumption within facilities with improvements to environmental protection. In so doing, recycling of thermal energy within industrial systems becomes part of the global sustainability and responsibility in utilizing resources.

TES can also be considered a great contributor to the decarbonization of heating and cooling systems that at particular points tend to utilize a large share of energy consumption globally. Buildings lessen their dependence on peak demand electricity and gain savings because of the stored thermal energy.

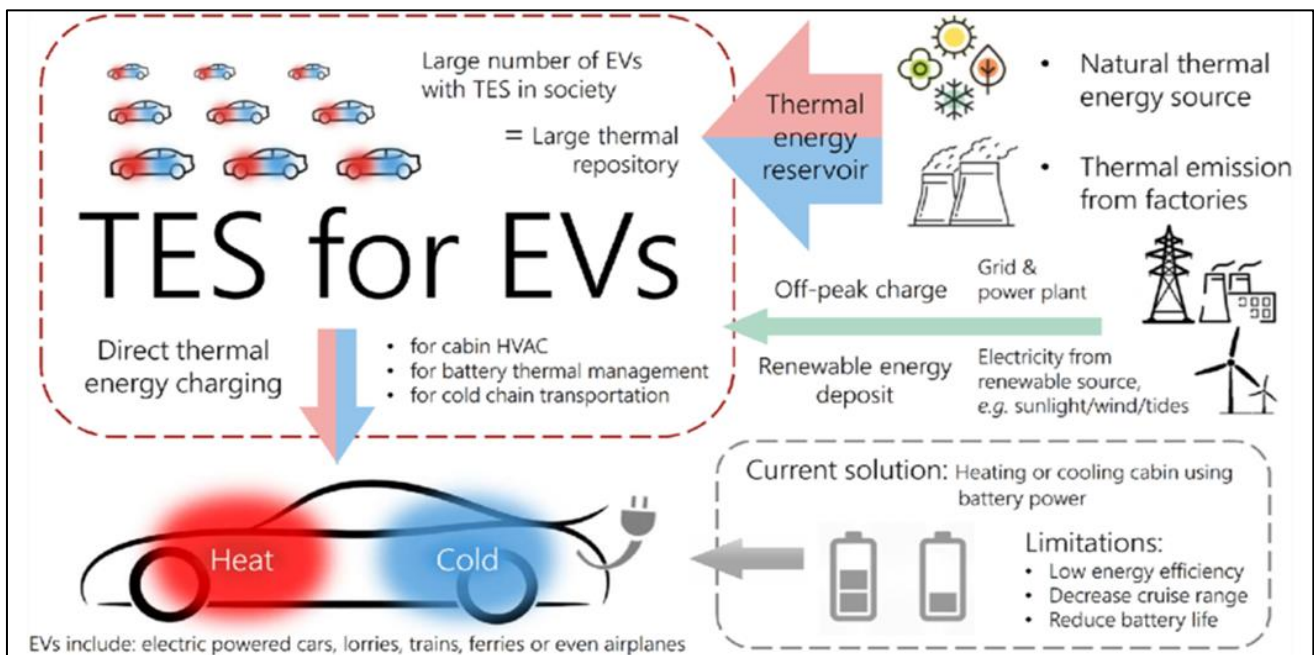

Figure 4 Applications and Potential benefits of Thermal Energy Storage System

1.3. Problem Statement

It is indeed the extreme pace at which the thermal energy storage (TES) technologies have advanced that has been up-to-date, making the ideal world of environmental sustainability and energy efficiency a reality. TES can build energy stores for renewably sourced electricity-generation technologies, especially solar and wind, so that they can be available

at times when required and overcome the existing intermittency hurdle that is using their production methods. But the current TES systems face various barriers and constraints like low energy density, thermal losses, poorly designed heat-exchanging mechanisms, and high capital cost, which made it impossible for general applications and optimization of thermal energy storage technologies for large-scale applications in the energy field.

All current thermal-energy storage systems, i.e. sensible heat, latent heat, and thermochemical storage, have some technical disadvantages that affect the performance and also the cost-effectiveness of that application. Sensible heat is available in large quantity, but large amounts of storage medium are needed, leading to space constraint. Latent heat storage using phase-change materials is the usually used method, but deficiencies like poor thermal conductivity and long-term stability have prevented their success. Moreover, though thermochemical energy storage is having an order of magnitude higher energy density, it is in an immature state having problems of material degradation and reversibility of reaction. All these are issues that restrict the efficiency of TES and the complete integration in renewable energy systems.

Still a challenge in TES systems' optimization, a number of past projects on performance assessment and optimization strategies have not started bridging the gap regarding synergistic balancing of energy storage capacity with thermal efficiency, cost-effective, and durability of the materials. Defining performance assessment standards will, therefore, serve as the missing link from the real world to market availability for TES. Furthermore, next-generation technologies for TES are rolled out every now and then; and consequently, significant studies need to be conducted regarding their applications, improvement of performance, and resulting economics, if seen as applying real-world systems to other sources of power.

Thus, it becomes very important to be able to progress towards an even more reliable and ultimately sustainable means of applying TES technology. Intensive performance evaluation and optimization of next-generation TES technologies based on advanced materials and novel heat-transfer mechanisms relative to their economic viability will be addressed. The course of this endeavor therefore aims to fill existing gaps in the knowledge spectrum to improve TES efficiency in the direction of a renewable transition toward a sustainable global energy infrastructure.

1.4. Objectives of the Study (Performance Analysis and Optimization)

The main focus of the study is the performance analysis and optimization of some next-generation thermal energy storage (TES) systems. Analysis, from the performance perspective, needs to include important parameters like energy storage capacity, thermal efficiency, heat transfer characteristics, charging/discharging rates, and stability of materials (Li et al., 2018). Comparative assessment for various thermal energy storage (TES) technologies to be evaluated for their relevance towards CSP, grid-scale storage, or large-scale industrial management of energy will be carried out. Optimization will target improving TES efficiency versus thermal losses and maximize desired material properties using advanced nanostructured materials and hybrid storage techniques. AI-based optimization approaches, including machine-learning algorithms, might also be integrated in the design and operation of TES systems. The project is targeted towards identifying the large-scale energy-utilizing area in which TES can be employed most economically and with intelligent energy use.

1.5. Scope of Next-Generation TES Technologies

Next-generation TES technologies are designed to address the limitations of traditional storage systems by offering higher energy densities, longer storage durations, and improved thermal stability. This study will focus on:

- Advanced Phase Change Materials (PCMs): Innovations in PCMs, including nanocomposite-enhanced materials, for improved heat absorption and release rates (Saha et al., 2021).
- High-Temperature Sensible Heat Storage Systems: Optimization of molten salts and other high-temperature materials for efficient energy retention in CSP applications (Li et al., 2022).
- Thermochemical Energy Storage (TCES): Emerging materials for chemical heat storage, offering superior energy density and long-term storage capabilities (Datas et al., 2018).

1.6. Research Questions

In this study, several key challenges with respect to performance and optimization of next-generation thermal energy storage (TES) systems are investigated. Based upon a thorough literature review regarding the existing works, the following research questions have been framed for the current investigation:

- What are the principal limitations of current TES technologies in terms of energy density, thermal efficiency and economic feasibility?

Existing thermal energy storage mediums, sensible, latent and thermochemical sources, have their different limitations regarding heat losses, limited energy density, and high material costs (Caraballo et al., 2021; Kant et al., 2017). Therefore, such limitations should be understood in terms of their impact upon the performance of TES.

- How can advanced materials and PCMs enhance the efficiency and thermal stability of thermal energy storage?

Research on next-generation materials such as nanostructured PCMs and composite materials has great promise for improvement in heat transfer and energy storage capacity (Li, Bashir, & Liu, 2018; Myers Jr & Goswami, 2016). This study hence investigates the role of novel materials in improving performance of TES.

- What are the optimization techniques that can be implemented for TES systems-maximizing thermal performance and cost-effectivity?

2. Literature Review

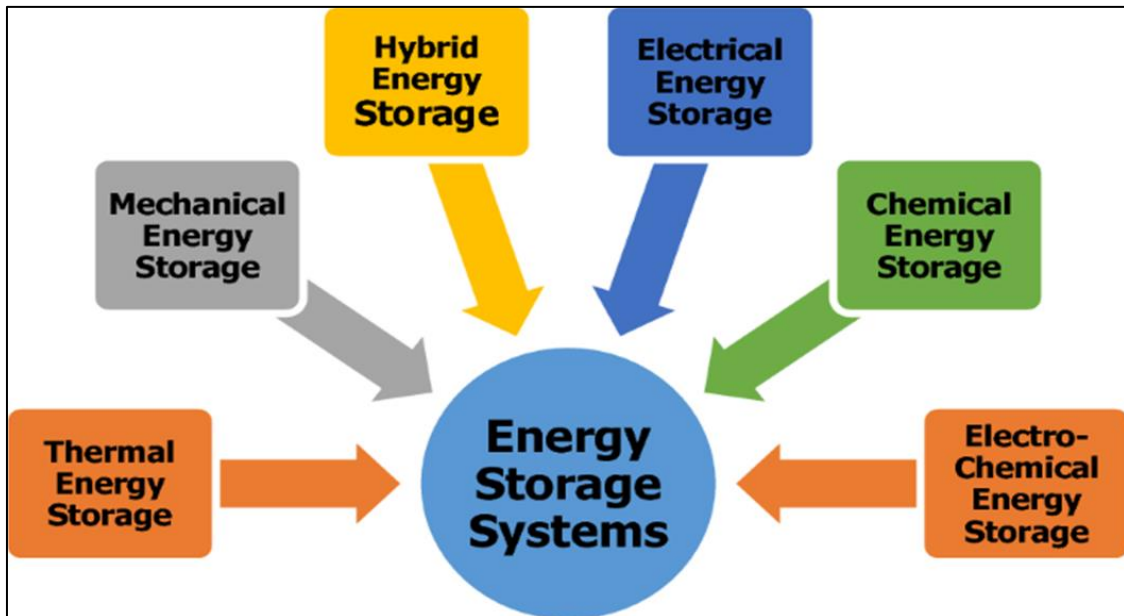

Figure 5 Energy Storage Techniques: Applications and recent trends

Over the past few decades, Thermal Energy Storage (TES) has evolved through interesting changes from basic thermal storage systems to the advanced next-gen solutions with promises of higher energy efficiency and integration with renewable energy sources. Dates of historical development lay back in the early days of heat recovery industries and solar energy applications. As the world demanded more efficient and reliable energy storage solutions, development took place in sensible heat storage using various materials such as molten salts, latent heat storage employing phase change materials (PCMs), and thermochemical storage systems that couple high-density energy storage with reversible chemical reactions (Caraballo et al., 2021).

It may well be speculated that the ever-increasing global energy demand coupled with the paradigm of self-moving shift towards renewable energy sources allowed the gradual development of TES. In the early days, the basic emphasis of TES was laid on the heat retention in insulated storage reservoirs. The modern sophistication of materials and storage mechanisms thus developed has increased energy retention and transfer capabilities tremendously. Sensible heat storage was earlier wholly based on simple materials like water and bricks. Now, high-performing modern materials like molten salts and ceramic-based composites are being used for good thermal stability and long storage. Latent heat storage has also upgraded to use advanced-phase change materials for better thermal regulation and energy densities (Kant, Shukla and Sharma, 2017). Thermochemical energy storage has further matured, since large energy storage densities can be achieved via reversible endothermic and exothermic reactions, making it an attractive option for large-scale applications (Caraballo et al., 2021).

Upgrading the thermal stability, heat transfer characteristics and economic feasibility as far as TES performance and efficiency is concerned are the main focus areas of the present work. Improvement of the efficiency of TES in CSP plants, as having a potential for storing energy during the hours of deep solar and the subsequent generation of electricity during periods of lower sunlight, has also been highlighted in a few studies (Saldivia et al., 2021). Also, pumped thermal energy storage have been optimized on various cycles of power for maximum energy conversion efficiency (Tian & Xi, 2022). Likewise, most of the research has been taken to optimization of high-temperature sensible heat TES systems for direct generation of steam, so simulation models have been developed to improve the performance parameters such as heat retention and thermal conductivity (Li, Zhang, & Feng, 2022). Additionally, also the integration of the TES with recovery of waste heat from industrial processes has proven very conducive, as an energy consumer will reduce benefits because the excess heat is produced during the manufacture of this product, which can be stored and reused, thus improving energy efficiency and sustainability (Mellouli et al., 2018).

Development in the next generation of TES materials and systems has covered all the possible dimensions for improving the energy storage potential. It also thought of including nanostructured materials for supplementing thermal conductivity and minimizing heat loss in TES systems (Li, Bashir, & Liu, 2018). The development of such self-repair materials for flexible energy storage applications has opened up yet another avenue to raise the durability and efficiency of TES systems (Wan, Mu, & Yin, 2023). Innovations in phase change materials have also provided better energy density and thermal performance stability in latent heat storage systems (Kant, Shukla, & Sharma, 2017). In addition, some studies have done on possible applications of paired metal hydrides all for TES in CSP plants. These studies prove promising regarding heat absorption- release efficiency (Mellouli et al., 2018). Hybrid TES systems using several storage mechanisms are being studied for sensible and latent heat. However, these efficiencies in total energy are looked for the least in heat loss (Baigorri, Zaversky, & Astrain, 2023).

Although very promising, most gaps still exist in current literature regarding the need for more research on optimization and scalability of TES systems. In addition, many TES systems are still struggling with very high costs of initial implementation and heat losses and degradation of materials. Many of such multi-objective optimization formulations for integrating with polygene ration grids in relation to TES have been proposed. However, large-scale practicality is still a very less explored domain (Ferrari et al., 2024). The economic feasibility of new generation TES technologies requires to be studied more, particularly concerning reduced material costs and increased lifespan of systems (Hamdan et al., 2024).

3. Fundamentals of Thermal Energy Storage

Thermal Energy Storage (TES) systems are a critical technology in the area of storing and regulating discharging of thermal energy for industrial operations, power generation, building heating, and cooling. Thermal Energy Storage's underlying principle is the ability to effectively absorb, store, and discharge thermal energy, thus creating an enabling environment for energy systems and improved resource utilization. The functioning of thermal energy storage systems depends on different principles based on the type of storage scheme applied, and a variety of technologies provide their unique merits with respect to energy density, efficiency, and thermal stability (Tian & Xi, 2022).

The taxonomy of TES generally distinguishes in three groups: sensible heat storage, latent heat storage, and thermochemical energy storage. For sensible heat storage, it is defined as methods of storing thermal energy by increasing the temperature of a certain medium like water, rocks, or molten salts. It is the simplest way of storage among CSPs and the cheapest option that uses molten salts as a storage medium (Caraballo et al., 2021). The thermodynamics of high-temperature sensible heat storage systems have been thoroughly analyzed, including some optimizations of its thermal characteristics aiming at boosting efficiency in direct steam generation (Li, Zhang, & Feng, 2022). Latent heat storage is an advanced thermal energy storage mechanism. Phase Change Materials (PCMs) serve in the storage of thermal energy in the heating mode, while releasing thermal energy during the melting or solidification process. This system gives a higher energy storage density as compared to sensible heat and is usually for very compact or efficient energy storage cases (Tiwari, Rai, & Srinivasan, 2021). The ongoing trend in modern research is directed toward the thermal conductivity and stabilization of PCMs to enhance TES performance. The coupling of PCMs with CSP holds prospects and potentials to prolong energy availability from sunlight hours for the effective system (Saldivia, Bilbao, & Taylor, 2021).

Thermochemical energy storage, denoting the thermodynamic process of employing chemical energy via reversible chemical reactions for the storage and release of thermal energy, is distinct in that it achieves a higher energy density as compared to sensible heat and latent heat storage. This aspect makes it a prime candidate for long-duration storage and for applications that require high temperatures. The use of metal hydrides incorporated into the thermochemical storage systems was also investigated in CSP for improvements in heat absorption and release (Mellouli et al., 2018).

The nanostructured materials' studies were aimed to be used to accelerate the reaction kinetics with high thermal conductivity for thermochemical storage, thereby emerging as a potential way forward for the next-gen TES technology (Li, Bashir, & Liu, 2018). The energy density, efficiency, and thermal stability are the key indicators in evaluating the performance of an application of TES. Energy density can be defined as energy stored per volume of the storage medium.

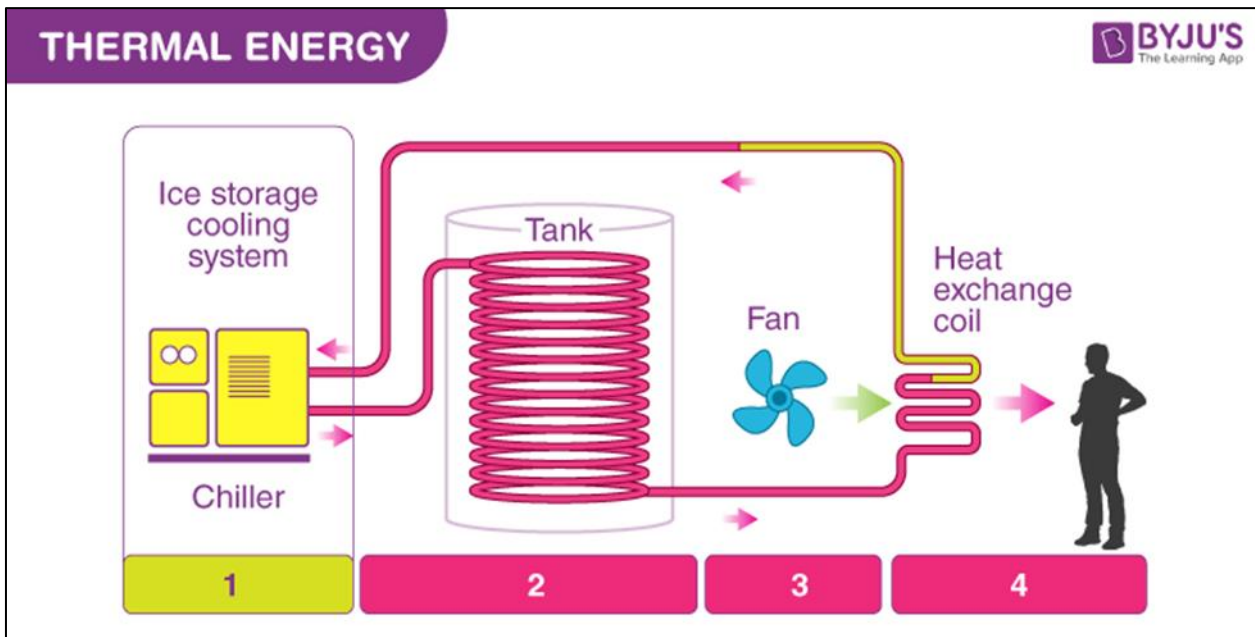

Figure 6 Working Principles of Thermal Energy Storage

4. Next-Generation TES Technologies

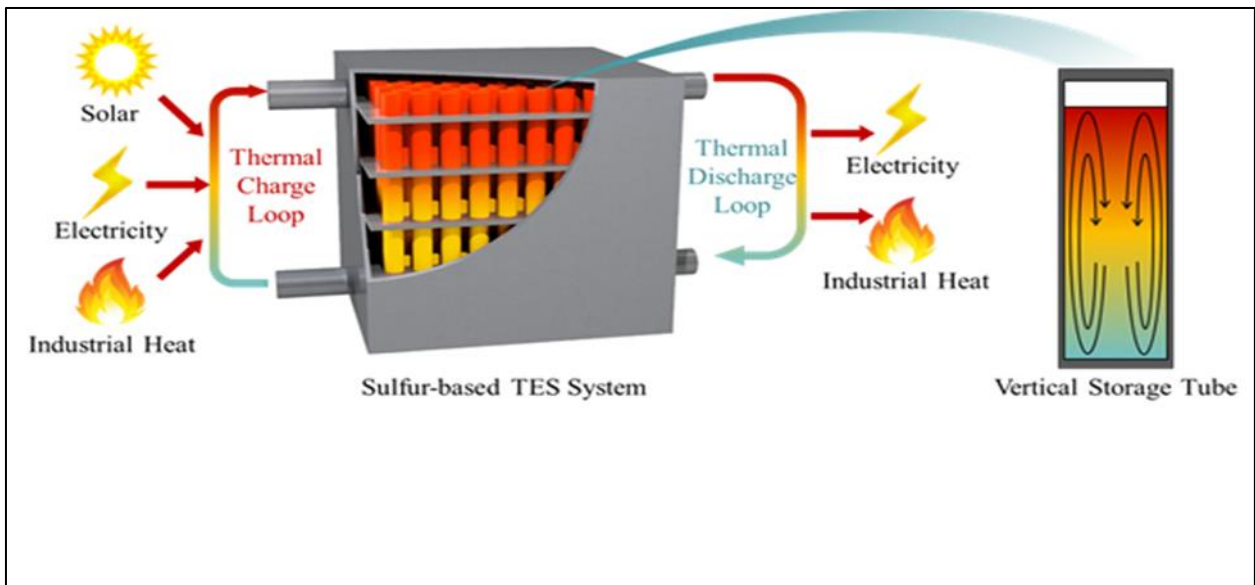

Figure 7 Next generation Thermal Energy Storage Technologies

New advances on high-temperature thermal energy storage (TES) technologies are made to get rid of some setbacks on existing systems, emphasizing storage density improvement, thermal stability, and overall efficiency gains. The modern phase change material (PCM) and nanocomposites now represent the ultimate engineering materials for TES applications and performance. Enhanced thermal conductivity of PCMs has been researched to be developed using carbon-based additives, metal nanoparticle- and graphene-based materials, among others. All these improvements work towards distributing heat more evenly in the storage medium to avoid supercooling and thermal degradation

(Kant, Shukla, & Sharma, 2017). The encapsulation of PCMs developed will greatly improve thermal cycling stability, thus poised for the larger-scale application (Saha et al., 2021).

An emergent and dominating type of storage for delving into high-temperature thermal energy is again in great demand, especially in TES for CSP application. Melting salts such as the chlorides and carbonate eutectics have witnessed optimization to show promising capabilities in the realm of high-efficiency thermal storage on account of their fantastic thermophysical properties and particularly low degradation rates (Myers & Goswami, 2016). Further work looked upon alumina and silicon carbide as ceramic-based storage media and their properties concerning heat retention for high temperature resilience (Caraballo et al., 2021). Such materials provide high energy-storing capacity and also cuts thermal losses, which is beneficial for high-performance TES systems for industrial and renewable energy applications (Li, Zhang, & Feng, 2022).

Hybrid TES systems combine sensible, latent, and thermochemical storage techniques to ameliorate the shortcomings of individual technologies standing alone. Integration of the latent heat storage with sensible heat materials is called hybrid and helps to improve stability and reliability so that energy can be more effectively retained and discharged (Tiwari, Rai, & Srinivasan, 2021). Recent studies were also conducted on matched metal hydrides used in CSP applications, showing increased thermal efficiency and optimized heat release cycles (Mellouli et al., 2018). The hybrid TES configurations, with multi-stage storage and cascading thermal management mechanisms, prove highly promising in enhancing energy conversion processes within polygeneration grids and industrial heat recovery systems (Ferrari et al., 2024).

All of these are emerging materials and new TES technologies that present possibilities for even more efficient and large-scale energy storage solutions. Especially in exploring the potential of graphene-enhanced storage systems, researchers are investigating their applications within energy technologies for their high thermal conductivities and mechanical robustness in respect to heat.

5. Methodology

A rigorous scientific approach is brought to views through such hybrid research methodologies, theory, experimentation, and simulation as reputable by requiring extensive evaluation of thermal energy storage (TES) subsystems. The experimental portion involves laboratory tests on TES materials and systems. Meanwhile, several calculation, modeling, and simulation tools for performance analysis constitute the comparative operating conditions. The hybrid approach exercises deep interpretation of the energy storage mechanism, its efficiency, and its potential for broadening optimization.

The techniques of data collection are hence oriented to both laboratory and simulation methods. The laboratory tests would include in-situ evaluation under controlled conditions of the thermal properties of such TES medium materials as molten salts, phase change materials, and metal hydrides. The results of such evaluation activities would comprise empirical data relating to thermal conductivity, specific heat capacity, and energy storage capacity. Experimental testbeds for sensible and latent heat TES systems assess thermal stability, heat retention, and overall performance. At the level of computation pertaining to data collection, simulation tools, which include Computational Fluid Dynamics (CFD), MATLAB, and ANSYS, are used to model the dynamics of heat transfer, phase change processes, and fluid flow behavior in different TES systems. The simulations predict the system's response to different thermal loads and environmental conditions.

Performance evaluations include several criteria, including energy efficiency, heat transfer, and life cycle assessment. Energy efficiency is determined by calculating the total energy that has been successfully discharged following the charging of TES systems. This is one of the main elements in determining whether or not the TES system proves feasible for actual use applications. On the other hand, heat transfer investigates conduction as well as convection and radiative effects in the TES materials as well as systems to provide the best thermal functionality. Life cycle assessment offers data on the application of TES technologies concerning materials sustainability, energy input, and the overall carbon footprint of TES.

Such optimization techniques and algorithms are also significant in enhancing the performance of the TES systems majored on further development. Multi-objective optimization techniques have been applied in this study to optimize energy efficiency, cost as well as material selection. Their application is through genetic algorithms and particle swarm optimization in the system's design and configuration for enhanced thermal storage and discharge efficiency optimization. These techniques form the core activity of predictive modeling and performance predictions via machine learning. Advanced cycle analysis ensures the refinement of power cycles for maximum efficiency, as depicted in

pumped thermal energy storage systems. The thermo-economic analysis adjudicates the optimized designs in terms of technical and economic feasibility.

6. Performance Analysis of TES Systems

These are a few important parameters that influence the performance of TES systems in their efficiency, thermal behavior, and broader feasibility across various applications, especially at larger scales. Among the critical factors, thermal conductivity is found to have a considerable influence on the rate of heat transfer in storage media. It turns out that materials with a high thermal conductivity would allow charging and discharging of such systems with more rapid heat transfer, thereby increasing the response time of the TES system towards any thermal disturbance. However, excessive heat losses can nullify these advantages, hence necessitating the application of effective insulation methods and composite materials for optimized performance (Myers Jr & Goswami, 2016).

Energy efficiency and losses from systems mostly help to evaluate practical applicability of TES technologies. Other sensible heat storage systems, like those based on molten salts, have very long periods in which they deliver heat losses and have much more improved storage containment designs (Caraballo et al., 2021). Latent heat TES use phase change materials (PCMs) which store very high energy densities with minimum losses. However, the problems of subcooling and degradation are significant hurdles in this technology (Kant et al., 2017). Next-generation TES systems are designed with nanostructured materials and self-healing chemistry to reduce such losses by maximizing thermal stability and resilience in structure (Li et al., 2018; Wan et al., 2023). In fact, charging and discharging rates are considered other aspects of performance metrics, with great importance attached for applications requiring very rapid thermal response. Efficiency of charging or discharging depends to a certain extent on the materials used and even more on the design of the incorporating system. For instance, high-temperature TES systems directly produce steam and require considerably improved designs of heat exchangers in order to provide efficient energy transfer between the systems and steam generators (Li, Zhang, & Feng, 2022). Concentrating solar power (CSP) plants are similarly aided by plants that use TES configurations to improve absorption and among others redistribution of heat, as shown in beam-down receiver designs and paired metal hydride storage systems (Saldivia et al., 2021; Mellouli et al., 2018).

Real benefits are clearly observed between conventional and next generation forms of TES systems. The traditional useful heat storage, or any such technology by two-tank molten salt systems, however, does provide a very robust low-cost design but, on the other hand, tends to suffer from large heat losses with time (Odukamaiya et al., 2021). The novel concepts based on A-CAES or adiabatic compressed air energy storage, in contrast with phase change-based TES, have shown better thermal retention and exergy efficiency (Li, Wang, & Tu, 2018; Tiwari, Rai, & Srinivasan, 2021). The advantage of hybridized systems from sensible, latent, and thermochemical storage is increased flexibility and versatility for specific energy profiles (Baigorri, Zaversky, & Astrain, 2023).

7. Optimization Strategies for TES

Optimization strategies for thermal energy storage (TES) systems have gained considerable importance to improve energy efficiency, optimize heat transfer characteristics, and allow seamless coupling with renewable energy sources. One of the major areas of optimization is material modification techniques. The selection of phase change materials (PCMs) and sensible heat storage materials is critical for the performance enhancement of TESs. For instance, the use of metal-enhanced PCMs and nanoparticle-doped materials with improved thermal conductivity properties can favorably enhance the heat transfer properties and reduce the thermal degradation of these composite materials for many charge-discharge cycles (Kant et al., 2017; Li, Bashir, & Liu, 2018). In addition, high-temperature molten salts and metal hydrides were examined to provide better thermal stability and energy density (Caraballo et al., 2021; Myers & Goswami, 2016).

The heat exchangers' and system design's improvement is also important for further optimizing and achieving high TES efficiency. The design of advanced heat exchangers, including shell-and-tube, packed bed, and fin structures, has been researched to improve their heat transfer and minimize thermal losses (Tehrani et al., 2016). Improved uniformly distributed flow in TES units by optimized arrangements of flow, such as serpentine and multi-pass channels, contributed to less temperature gradient, thereby reducing exergy losses and increasing overall efficiency (Mellouli et al., 2018). Additionally, innovative designs of receivers in CSP plants, such as beam-down configurations, have been manufactured to improve solar energy absorption and effective storage in TES systems (Saldivia, Bilbao, & Taylor, 2021).

Integrating artificial intelligence and machine learning into TES optimization has set the scene for predictive modeling and real-time control strategies. These advanced computational techniques permit the accurate forecasting of charging and discharging cycles, optimization of the material selection process, and identification of optimal operational parameters to ensure maximum efficiency. Studies have confirmed the applications of ML algorithms in the prediction of thermal behavior, optimizing TES configurations, and automation control-based reduction of inefficiencies (Ferrari et al., 2024; Tian & Xi, 2022). Optimization frameworks driven by AI have also been used to optimize the configurations of hybrid energy systems to improve their economics and energy performance (Li, Wang, & Tu, 2018).

For the seamless integration of TES with renewable energy sources, further testing involves the following: The combination of TES with solar thermal power plants, wind energy, and hybrid energy systems provide uninterrupted energy supply even during the times of intermittence. For example, high-temperature molten salts are used as sensible heat storage coupled with CSP plants.

8. Case Studies and Real-World Applications

In all these areas, a lot can be done in terms of energy efficiency and sustainability with thermal energy storage systems. One of the most important applications is recovered in industrial waste heat recovery, where thermal energy storage technologies collect and store wide-ranging amounts of excess heat obtained from industrial processes-retrieval-the later use. "For example, major processes where waste heat is produced by TS, such as steel production, glass making, and chemical processing, have the potential to generate considerable waste heat which, when unutilized, bears the same and causes thermal pollution and energy losses." Currently, molten salt storage and phase change materials (PCMs) technologies are optimized concerning these applications' high energy retention and recovery efficiencies such that experimental studies have proved that the integration of TES in industrial installations leads to huge cost savings and decreases fossil fuels.

In the renewable sector, TES becomes an obligatory part of solar thermal power plants, as they store energy from the sun when the sun is out quite well; aside from this, the other methods of solar energy application that exist in CSP plants use storage systems to put away any surplus solar thermal energy, primarily during peak sunlight hours via molten salts. This energy is then transforms into electricity whenever there is no solar radiation or at night. Many studies showed that TES integration in CSP plants worked quite well in terms of enhancing energy dispatchability and efficiency. Other cutting-edge technologies have adopted new pathways that make further advances in TES applications in solar energy-specific high-temperature storing materials and beam-down receiver systems.

TES solutions have been a key area in district heating systems, particularly in cities, where the demand for power fluctuates on a large scale. Thermal Energy Storage (TES) systems store thermal energy during off-peak times and release it during peak demand, thereby establishing availability and efficiency. Including water or PCM-based TES systems will help cities better balance energy delivery, reduce fossil fuel dependency, and ultimately lower carbon emissions. The application of a TES has been very popular among European nations since many sustainable energy policies highly endorse it. Dramatically, there is also more avenue that is becoming introduced to TES applications, such as energy balancing in electric grid and demand-side management.

Storing excess energy when generation is high and then discharging it when demand spikes maintains supply equal to demand, while at the same time TES systems can do grid balancing. The concepts of "advanced" TES high-performance solutions are being considered for grid applications, such as adiabatic compressed air energy storage and thermochemical energy storage. As a result, the introduction of various AI and machine learning algorithms for optimizing TES operations in the management of power grids further motivates the improvement of response time and energy efficiency. These practical applications will tell how versatile TES technology.

Table 1 The Applications of Thermal Energy Storage (TES) Across Different Sectors

Sector	Application	TES Technology Used	Benefits
Industrial Waste Heat Recovery	Capturing and storing excess heat from industrial processes	Molten salt storage, Phase Change Materials (PCMs)	Reduces thermal pollution, improves energy efficiency, lowers fossil fuel consumption
Renewable Energy	Storing excess thermal energy in Concentrated Solar Power (CSP) plants	Molten salts, High-temperature storage	Enhances energy dispatchability, increases efficiency, ensures electricity availability at night

(Solar Power)		materials, receivers	Beam-down	
District Heating and Cooling	Stabilizing energy supply in urban heating networks	Molten salts, High-temperature materials, receivers	High-storage Beam-down	Reduces fossil fuel reliance, lowers carbon emissions, optimizes energy distribution

9. Challenges and Future Perspectives

The performance and scalability of thermal energy storage (TES) systems are now hindered by several restrictions. One aspect is the energy conversion and retrieval efficiency, including thermal losses during storage and discharge; direct storage systems, such as molten salts, suffer because these high-temperature heat storage systems are severely affected by time-dependent losses, thereby creating reduced efficiencies of the systems. Additionally, scalability has remained a challenge in designing TES systems of large capacities for industrial and grid applications. Some advanced materials, like phase change materials (PCMs) and thermochemical systems, offer some promise, but they probably also require optimization in terms of use and cost efficiency and their interaction compatibility with the existing energy infrastructures (Kant et al., 2017; Saha et al., 2021).

Besides the merits TES technologies seem to offer, these technologies are clearly limited by economic and environmental considerations. While the very high initial cost of capital investments for system setup, material acquisition, and maintenance forms a bottleneck to large-scale implementation in developing areas, unless linked with the sustainable energy source, less economically viable is the active operation of TES vis-a-vis cycling features. Environmental issues on resource extraction from and disposal of TES materials would have to be mitigated. Sustainability and recyclability concerns were raised on specific salts and composites used in TES systems (Caraballo et al., 2021; Myers Jr. & Goswami, 2016). Therefore, a priori, this necessitates research into eco-friendly materials and efficient storage systems to strip off these concerns and improve the compatibility of such technologies to TES.

Thus, there is a need for policy and regulatory frameworks in view of the adoption and promotion of TES technologies. There are supportive schemes, subsidies, and schemes for energy, which are pivotal for pushing TES as one of the attractive energy storage options. In many parts of the world, regulatory uncertainties and lack of a clear guideline or framework about the coupling of TES with power grids have obstructed the flow of investments and innovativeness. Policy backing for research and development, tax incentives to encourage TES applications, and compulsion on renewable energy storage will expedite widespread acceptance. Furthermore, utility companies must embrace adopting TES as the core component in demand-side management in terms of market mechanisms to foster grid reliability and energy efficiency (Ferrari et al., 2024; Odukomaiya et al., 2021).

Advances in smart grid integration and energy management strategies, as well as advances in materials science, are expected to continue driving future growth for TES. Applications of nanostructured materials and self-healing chemistries are poised to potentially unlock the energy density along with longevity of systems (Wan et al., 2023; Li et al., 2018).

10. Conclusion

Thermal energy storage (TES) technology is an important tool for energy sustainability since it provides answers to the intermittency problems of renewable energy systems. Different analytical methods on sensible heat, latent heat, and thermochemical storage indicate that TES improves energy efficient and steady-state operation of power grids. An improved performance of TES systems was seen at the materials to be developed; integration of systems; and novel heat transfer methods. The developments include cerebral attractor; pumped thermal energy storage; molten salts; phase-change materials; and auxiliary systems with their modifications, earning significant prospects for improvements in energy densities, thermal efficiencies, and life expectancy. However, thermal losses, degradation of materials, and scalability remain the principal challenges on the way towards large-scale implementation.

In an extremely significant sense, the implications for energy sustainability stemming from TES development are quite broad. Whereas timescales govern the storage and release of energy, TES can indeed further stimulate renewable energy sources' credence, thereby diminishing dependence on fossil fuels and carbon emissions. TES gained clinch due to this fascinating synergy with solar and wind energy and being proven as a grid-scale energy storage option. The whole notion of TES is really evident within heating and cooling applications for conservation of energy and reduction of

emissions in both industrial and residential contexts. Economic and environmental analysis shows that, having a high weight-on capital in the very beginning, the operating savings and sustainability credentials will, at due course, justify their acceptance.

Possible future discussions should tackle and explore restricting processes concerning major limitations of these thermal energy storage technologies. Enhanced materials relevant to cooling based on phase change storage or thermochemical storage materials would give an edge in efficiency and longevity. Irrespective of these specific instances, other avenues of research should consider hybrid storage systems integrating TES and other electric and mechanical storage methods. Furthermore, a path towards large-scale deployment and integration at the operational end of existing energy systems will be paved if regulatory frameworks are created to engender incentives for and proffer encouragement to TES adoption. Such a collaborative effort, cutting across disciplines with researchers, policymakers, and industry players, ought to sustain, as is a generator force for rapid TES development to unlock its full potential for sustainable energy future.

References

- [1] Tian, W., & Xi, H. (2022). Comparative analysis and optimization of pumped thermal energy storage systems based on different power cycles. *Energy Conversion and Management*, 259, 115581.
- [2] Li, Y. C., Zhang, L., & Feng, B. (2022). Optimization of thermal performance of high temperature sensible heat thermal energy storage system for direct steam generation: A simulation work. *Applied Thermal Engineering*, 217, 119225.
- [3] Tiwari, V., Rai, A. C., & Srinivasan, P. (2021). Parametric analysis and optimization of a latent heat thermal energy storage system for concentrated solar power plants under realistic operating conditions. *Renewable Energy*, 174, 305-319.
- [4] Saldivia, D., Bilbao, J., & Taylor, R. A. (2021). Optical analysis and optimization of a beam-down receiver for advanced cycle concentrating solar thermal plants. *Applied Thermal Engineering*, 197, 117405.
- [5] Baigorri, J., Zaversky, F., & Astrain, D. (2023). Massive grid-scale energy storage for next-generation concentrated solar power: A review of the potential emerging concepts. *Renewable and Sustainable Energy Reviews*, 185, 113633.
- [6] Li, R., Wang, H., & Tu, Q. (2018). Thermo-economic analysis and optimization of adiabatic compressed air energy storage (A-CAES) system coupled with a Kalina cycle. *Energy technology*, 6(6), 1011-1025.
- [7] Caraballo, A., Galán-Casado, S., Caballero, Á., & Serena, S. (2021). Molten salts for sensible thermal energy storage: a review and an energy performance analysis. *Energies*, 14(4), 1197.
- [8] Hamdan, A., Daudu, C. D., Fabuyide, A., Etukudoh, E. A., & Sonko, S. (2024). Next-generation batteries and US energy storage: A comprehensive review: Scrutinizing advancements in battery technology, their role in renewable energy, and grid stability. *World Journal of Advanced Research and Reviews*, 21(1), 1984-1998.
- [9] Datas, A., Cristobal, A. B., del Cañizo, C., Antolín, E., Beaughon, M., Nikolopoulos, N., ... & Martí, A. (2018, November). AMADEUS: Next generation materials and solid state devices for ultra high temperature energy storage and conversion. In *AIP Conference Proceedings* (Vol. 2033, No. 1). AIP Publishing.
- [10] Kant, K., Shukla, A., & Sharma, A. (2017). Advancement in phase change materials for thermal energy storage applications. *Solar Energy Materials and Solar Cells*, 172, 82-92.
- [11] Saha, S., Ruslan, A. R. M., Monjur Morshed, A. K. M., & Hasanuzzaman, M. (2021). Global prospects and challenges of latent heat thermal energy storage: A review. *Clean Technologies and Environmental Policy*, 23, 531-559.
- [12] Odukomaiya, A., Woods, J., James, N., Kaur, S., Gluesenkamp, K. R., Kumar, N., ... & Prasher, R. (2021). Addressing energy storage needs at lower cost via on-site thermal energy storage in buildings. *Energy & Environmental Science*, 14(10), 5315-5329.
- [13] Myers Jr, P. D., & Goswami, D. Y. (2016). Thermal energy storage using chloride salts and their eutectics. *Applied thermal engineering*, 109, 889-900.
- [14] Ferrari, M. L., Gini, L., Di Barba, P., Mognaschi, M. E., & Sieni, E. (2024). Multi-objective optimization of a polygeneration grid including thermal energy storage system. *Journal of Energy Storage*, 97, 112963.
- [15] Li, F., Bashir, S., & Liu, J. L. (2018). Nanostructured Materials for Next-Generation Energy Storage and Conversion. *Fuel Cells*, 1.

- [16] Wan, X., Mu, T., & Yin, G. (2023). Intrinsic self-healing chemistry for next-generation flexible energy storage devices. *Nano-Micro Letters*, 15(1), 99.
- [17] Mellouli, S., Askri, F., Edacherian, A., Alqahtani, T., Algarni, S., Abdelmajid, J., & Phelan, P. (2018). Performance analysis of a thermal energy storage system based on paired metal hydrides for concentrating solar power plants. *Applied Thermal Engineering*, 144, 1017-1029.
- [18] Musharavati, F., Khanmohammadi, S., & Mansir, I. B. (2022). Design, exergy analysis, and optimization of a hydrogen generation/storage energy system with solar heliostat fields and absorption-ejector refrigeration system. *International Journal of Hydrogen Energy*, 47(62), 25945-25963.
- [19] Tehrani, S. S. M., Taylor, R. A., Saberi, P., & Diarce, G. (2016). Design and feasibility of high temperature shell and tube latent heat thermal energy storage system for solar thermal power plants. *Renewable Energy*, 96, 120-136.
- [20] Zeng, Q., Lai, Y., Jiang, L., Liu, F., Hao, X., Wang, L., & Green, M. A. (2020). Integrated photo rechargeable energy storage system: next-generation power source driving the future. *Advanced Energy Materials*, 10(14), 1903930.
- [21] Sadeghi, G. (2022). Energy storage on demand: Thermal energy storage development, materials, design, and integration challenges. *Energy Storage Materials*, 46, 192-222.
- [22] Koochi-Fayegh, Seama, and Marc A. Rosen. "A review of energy storage types, applications and recent developments." *Journal of Energy Storage* 27 (2020): 101047.
- [23] Peón Menéndez, R., Martínez, J. Á., Prieto, M. J., Barcia, L. Á., & Martín Sánchez, J. M. (2014). A novel modeling of molten-salt heat storage systems in thermal solar power plants. *Energies*, 7(10), 6721-6740.
- [24] Zhao, W., Lin, X., Zhang, T., & Ding, Y. (2024). Large-scale energy storage for carbon neutrality: thermal energy storage for electrical vehicles. *Carbon Neutrality*, 3(1), 30.
- [25] Vaghela, P., Pandey, V., Sircar, A., Yadav, K., Bist, N., & Kumari, R. (2023). Energy storage techniques, applications, and recent trends: A sustainable solution for power storage. *MRS Energy & Sustainability*, 10(2), 261-276.
- [26] Admin. (2023, April 7). Thermal Energy | Thermal Energy Storage - Working principle | Applications. BYJUS. <https://byjus.com/physics/thermal-energy/>
- [27] Longworth. (2019, October 28). SulfurTES: Next-generation thermal energy storage. *Advances in Engineering*. <https://advanceseng.com/sulfurtes-next-generation-thermal-energy-storage/>